

<u>BALLS</u>	<u>PITCH</u>	<u>SIZE</u>	<u>MATRIX</u>	<u>ROWS</u>	<u>CENTER</u>	<u>MAT'L</u>
672	1.0mm	27mm SQ	full	26x26	full	FR4

BALL VIEW

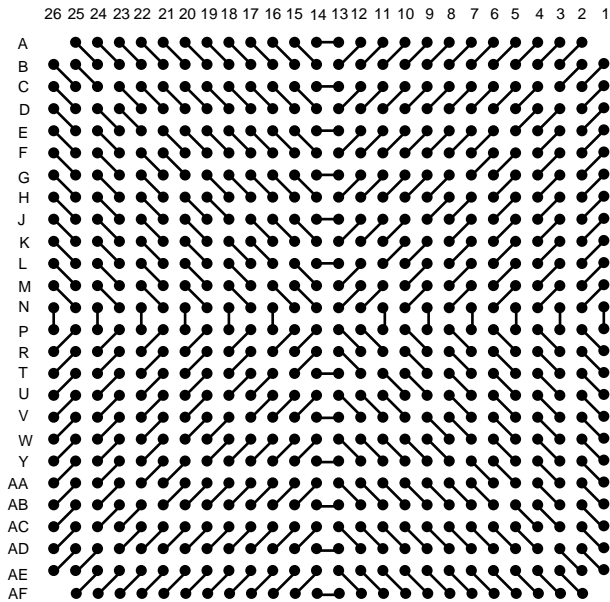

BOTTOM SIDE (TOP X-RAY VIEW)

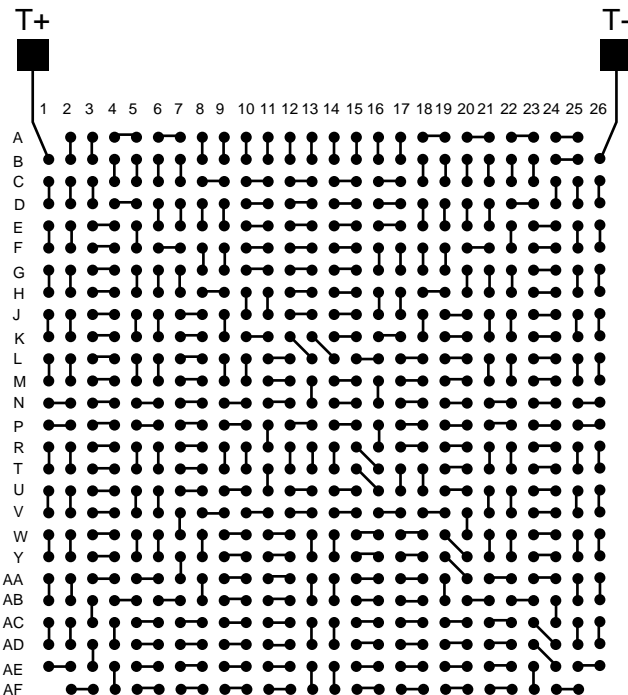
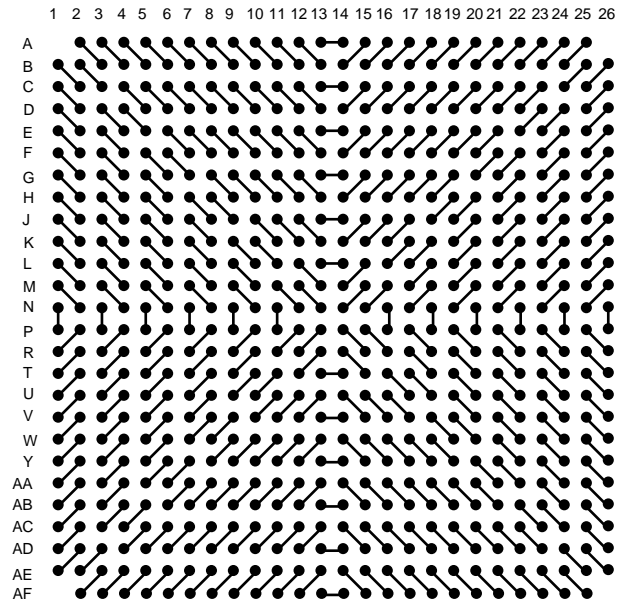

TEST VEHICLE BOARD

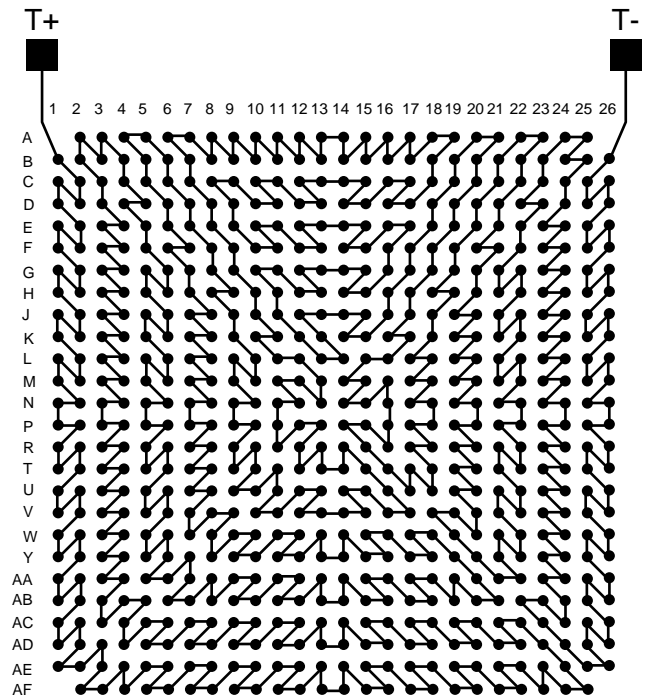

AFTER MOUNTING TO TEST BOARD

eBGA672T1.0-D268D



Tel 1-714-898-3830
info@topline.tv

<u>BALLS</u>	<u>PITCH</u>	<u>SIZE</u>	<u>MATRIX</u>	<u>ROWS</u>	<u>CENTER</u>	<u>MAT'L</u>
672	1.0mm	27mm SQ	full	26x26	full	FR4

TOP VIEW

SIDE VIEW

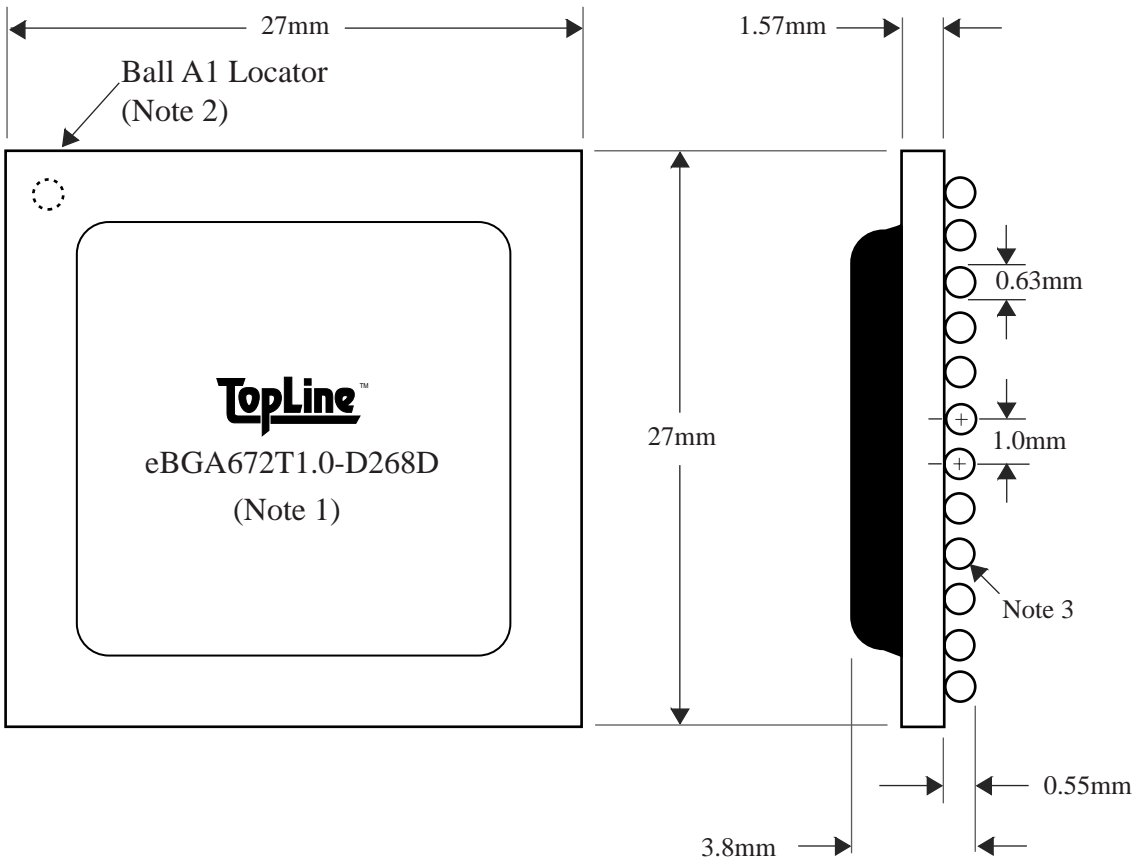

NOTES		REVISIONS		
Note 1	Logo and part number centered	<u>Rev</u>	<u>Date</u>	<u>Changes</u>
Note 2	Ball A1 locator mark positioned in corner			
Note 3	Ball Material: Sn63/Pb37			
Note 4	Substrate Material: FR4			
		PACKAGING TRAYS		
		Tray BGATRAY27mm-4x10		
		Tray Quantity 40		

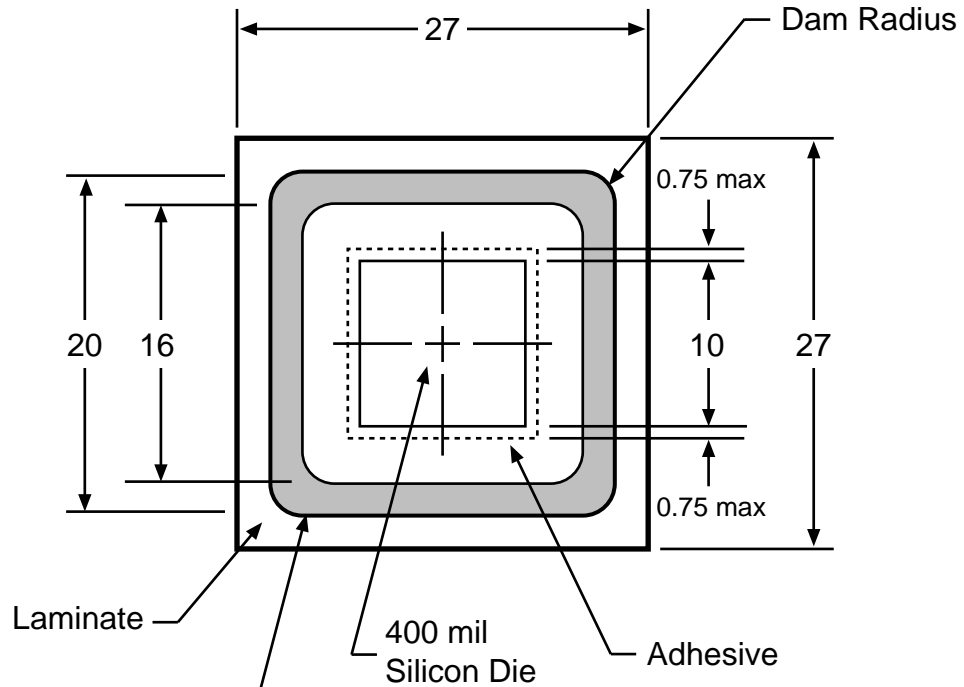

Top View

Shown Open Cavity

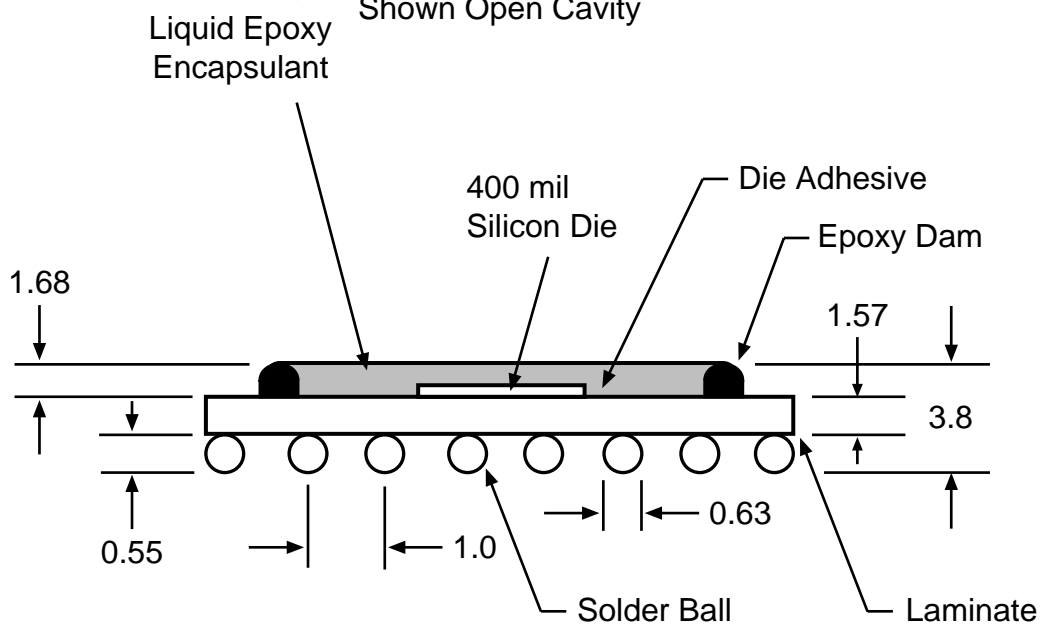

Side View

Drawing Not to Scale
Dimensions = mm